

“ A good bracket is the foundation of a good treatment plan ... Go ahead, choose the best.”



Metal Bracket

Precimax

X.B.H

Iridium

Econo

Fun Series

Lingual Bracket

Aesthetic Bracket

Cerabrace

Krystal Ice

Self Ligating Bracket

Swing

Bracket Systems



Precimax™ Series

MIM MBT *prescription brackets

Features

- Exacting MIM tolerances of + .0005" create precise slots
- Nickel- free bio- compatible materials
- Superior base design for stronger bond
- Smooth, round edges and hooks increase patient comfort
- Full radius low- profile design
- Anatomically contoured
- Integral Metal Injection Moulded with "Tuff Lock" base

Every detail and characteristic of the bracket prescription, developed by Drs. **McLaughlin-Bennet-Trevisi** Bracket (MBT), is now available in Precimax™. The Precimax™ version provides excellent working mechanics - the result of carefully adjusted torque and in/out forces that are applied to the center of the slot in to the base. The following are detail that characterizes this new prescription:

- Tip in the slot
- Specific modelling of brackets
- Torque at the base
- I.D. System
- In/out at the base

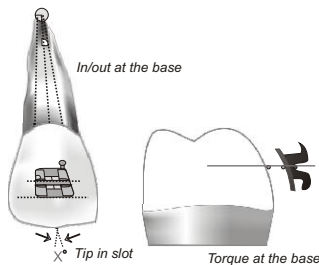

“Created with high quality stainless steel, the bracket’s low profile and built-in torque and angulation make it one of the most comfortable brackets available”



MBT PRESCRIPTION BRACKETS			DIRECT BOND .018 & .022		
Maxillary	Torque	Angle	Offset	Right/Left	Hook
Central	+17	+4	0	● Right ● Left	
Lateral	+10	+8	0	● Right ● Left	
Cuspid	-7	+8	0	● Right ● Left	Hook Hook
Bicuspid	-7	0	0	● Right ● Left	Hook Hook
1st/2nd Molar Single Tube	-14	0	+10	Right Left	Hook Hook

MBT PRESCRIPTION BRACKETS			DIRECT BOND .018 & .022		
Mandibular	Torque	Angle	Offset	Right/Left	Hook
Anteriors	-6	0	0	● Universal	
Cuspid	-6	+3	0	● Right ● Left	Hook Hook
1st Bicuspid	-12	+2	0	● Right ● Left	Hook Hook
2nd Bicuspid	-17	+2	0	○ Right ○ Left	Hook Hook
1st Molar Single Tube	-20	0	0	Right Left	Hook Hook

Full Sets	Hook
Full set (20 bracket)	Hooks on 3's, 4's & 5's

* Custom kits available upon request.

Colour Code/Identification Chart

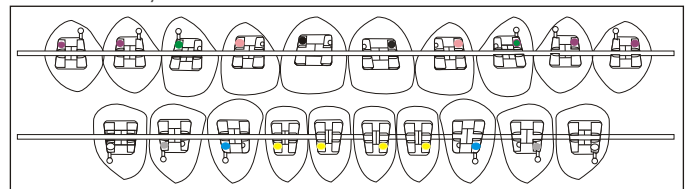

* D-Tech Precimax MBT Prescription does not imply an endorsement by the doctors.



Precimax™ Series

MIM Roth prescription brackets*

Features

- Exacting MIM tolerances of + .0005" create precise slots
- Nickel- free bio- compatible materials
- Superior base design for stronger bond
- Smooth, round edges and hooks increase patient comfort
- Full radius low- profile design
- Anatomically contoured
- Integral Metal Injection Moulded with "Tuff Lock" base

ROTH PRESCRIPTION BRACKETS		DIRECT BOND .018 & .022		
Maxillary	Torque	Angle	Right/Left	Hook
Central	+12	+5	● Right ● Left	
Lateral	+8	+9	● Right ● Left	
Cuspid	-2	+13	● Right ● Left	Hook Hook
Bicuspid	-7	0	● Right ● Left	Hook Hook
1st Molar <i>Single Tube</i>	-14	0	Right Left	Hook Hook

ROTH PRESCRIPTION BRACKETS		DIRECT BOND .018 & .022		
Mandibular	Torque	Angle	Right/Left	Hook
Anteriors	0	0	● Universal	
Cuspid	-11	+7	● Right ● Left	Hook Hook
Bicuspid	-17	0	○ Right ○ Left	Hook Hook
Bicuspid	-22	0	● Right ● Left	Hook Hook
1st Molar <i>Single Tube</i>	-25	0	Right Left	Hook Hook

Full Sets	Hook
Full set (20 bracket)	Hooks on 3's, 4's & 5's

* Custom kits available upon request.

Sintered Zirconia balls at the base improves bonding strength

Colour Code/Identification Chart

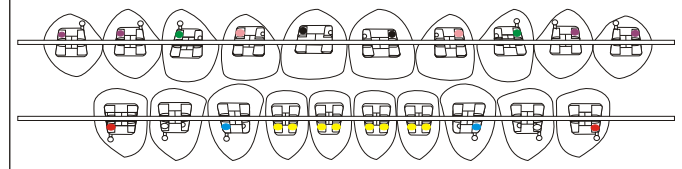

“Engineered for Maxi MIM efficiency, our Precimax™ Roth Brackets provide all the benefits of a full sized bracket, while incorporating all the aesthetics of a mini bracket”

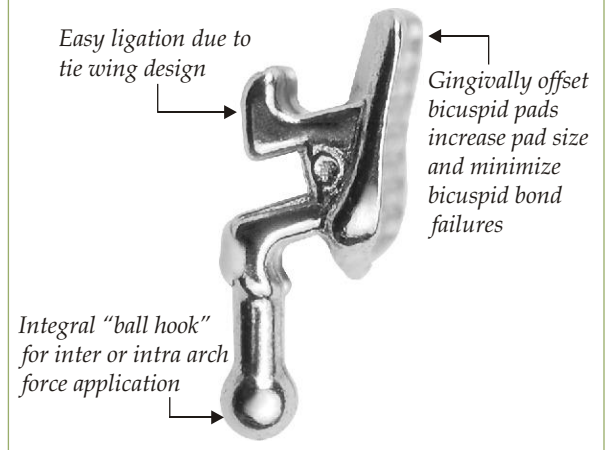

XBH™ Series

Roth Prescription Mini Brackets

Features

- Mini size bracket with torque in base.
- Sturdy & high stress resistance in spite of small size.
- Exceptional comfort and appearance.
- Special foil mesh pad for maximum retention and easy debonding.
- Available in .018 & .022 slots.
- Colour coded by quadrant.
- Hooks available on cuspids and bicuspid.

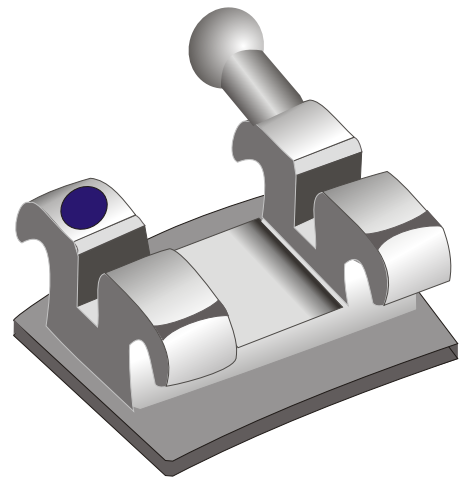

Roth Prescription Classic Brackets

Features

- Comfort sized brackets with low profile.
- Extremely functional and comfortable.
- Hooks on Cuspids & Bicuspid.
- Foil mesh pads give excellent retention and easy debonding.
- Easy identification with distogingival color markings.

ROTH PRESCRIPTION BRACKETS		DIRECT BOND .018 & .022		
Maxillary	Torque	Angle	Right/Left	Hook
Central	12°	5°	● Right ● Left	
Lateral	8°	9°	● Right ● Left	
Cuspid	-2°	13°	● Right ● Left	Hook Hook
Bicuspid	-7°	0°	● Right ● Left	Hook Hook
1st Molar <i>Single Tube</i>	-14	0	Right Left	Hook Hook

MBT Prescription Brackets

Features

- Mini size bracket with torque in base.
- Sturdy & high stress resistance in spite of small size.
- Exceptional comfort and appearance.
- Special foil mesh pad for maximum retention and easy debonding.
- Available in .018 & .022 slots.
- Colour coded by quadrant.
- Hooks available on cuspids and bicuspid.

ROTH PRESCRIPTION BRACKETS		DIRECT BOND .018 & .022		
Mandibular	Torque	Angle	Right/Left	Hook
Anteriors	0	0	○ Universal	
Cuspid	-11°	+7°	● Right ● Left	Hook Hook
Bicuspid	-17°	-1°	● Right ● Left	Hook Hook
Bicuspid	-22°	-1°	● Right ● Left	Hook Hook
1st Molar <i>Single Tube</i>	-25	0	Right Left	Hook Hook

Full Sets	Hook
Full set (20 bracket)	Hooks on 3's, 4's & 5's

* Custom kits available upon request.

D- Tech XBH multi case dispensers can hold up to 25 complete cases of 20 bracket set ups.



XBH™ Fun Series

XBH Series users have the option of ordering upper anteriors (3-3) in fun series. Unique shapes add to the fun factor Kids love it!!

Anterior of XBH (upper 3-3) available in Fun Series.



Iridium™ Series

MBT prescription Mini Brackets

Features

- Mini size bracket with torque in base.
- Sturdy & high stress resistance in spite of small size.
- Exceptional comfort and appearance.
- Special foil mesh pad for maximum retention and easy debonding.
- Available in .018 & .022 slots.
- Colour coded by quadrant.
- Hooks available on cuspids and bicuspid.
- Bright mesh - New mesh gives a very bright look & great bonding.
- Laser mark - All bracket are laser marked at the back for easy identification.

* Available in both Roth, MBT & Edgewise prescriptions

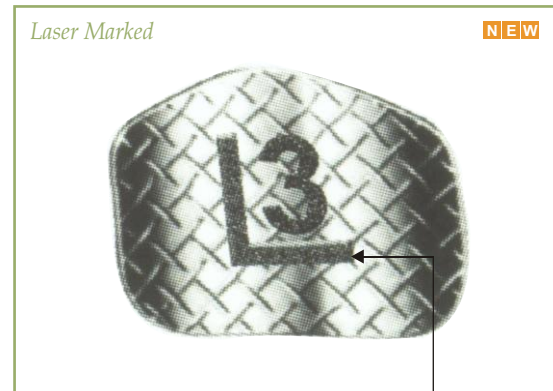

Iridium series introduces the new “diffusion welded” mesh. This eliminates any chance of mesh failure.

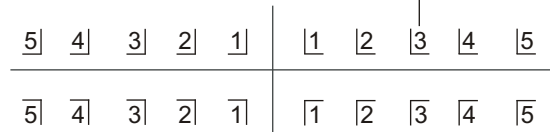

MBT PRESCRIPTION BRACKETS			DIRECT BOND .018 & .022		
Maxillary	Torque	Angle	Offset	Right/Left	Hook
Central	+17	+4	0	● Right ● Left	
Lateral	+10	+8	0	● Right ● Left	
Cuspid	-7	+8	0	● Right ● Left	Hook Hook
Bicuspid	-7	0	0	● Right ● Left	Hook Hook
1st/2nd Molar Single Tube	-14	0	+10	Right Left	Hook Hook

ROTH PRESCRIPTION BRACKETS			DIRECT BOND .018 & .022		
Maxillary	Torque	Angle	Right/Left	Hook	
Central	+12	+5	● Right ● Left		
Lateral	+8	+9	● Right ● Left		
Cuspid	-2	+13	● Right ● Left	Hook Hook	
Bicuspid	-7	0	● Right ● Left	Hook Hook	
1st Molar Single Tube	-14	0	Right Left	Hook Hook	

MBT PRESCRIPTION BRACKETS			DIRECT BOND .018 & .022		
Mandibular	Torque	Angle	Offset	Right/Left	Hook
Anteriors	-6	0	0	● Right ● Left	
Cuspid	-6	+3	0	● Right ● Left	Hook Hook
1st Bicuspid	-12	+2	0	● Right ● Left	Hook Hook
2nd Bicuspid	-17	+2	0	● Right ● Left	Hook Hook
1st Molar Single Tube	-20	0	0	Right Left	Hook Hook

ROTH PRESCRIPTION BRACKETS			DIRECT BOND .018 & .022		
Mandibular	Torque	Angle	Right/Left	Hook	
Anteriors	0	0	● Right ● Left		
Cuspid	-11	+7	● Right ● Left	Hook Hook	
Bicuspid	-17	0	● Right ● Left	Hook Hook	
Bicuspid	-22	0	● Right ● Left	Hook Hook	
1st Molar Single Tube	-25	0	Right Left	Hook Hook	

Econo Series

Roth Prescription Mini Brackets

Features

- Mini size bracket with torque in base.
- Sturdy & high stress resistance in spite of small size .
- Exceptional comfort and appearance.
- Available in .018 & .022 slots.
- Colour coded by quadrant.
- Hooks available on cuspids.

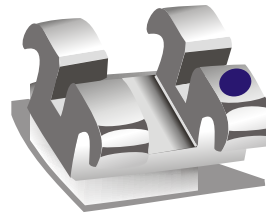

Roth Prescription Classic Brackets

Features

- Comfort sized brackets with low profile.
- Extremely functional and comfortable.
- Hooks on Cuspids.

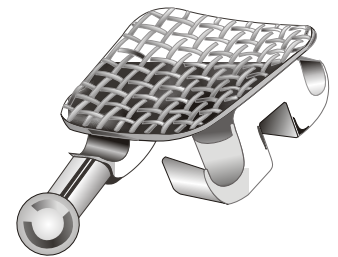

M.B.T Prescription Brackets

Features

- Comfort sized brackets with low profile.
- Extremely functional and comfortable.
- Hooks on Cuspids.

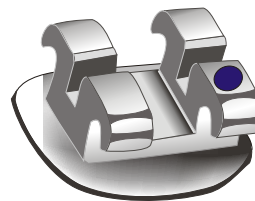

Edgewise Prescription Brackets

Features

- Low profile brackets for patient comfort.
- Anatomically contoured base matches tooth contour for stronger bonding.
- Rounded side of base is bonded toward the gingiva to ensure proper bracket placement.
- Hooks on Cuspids.

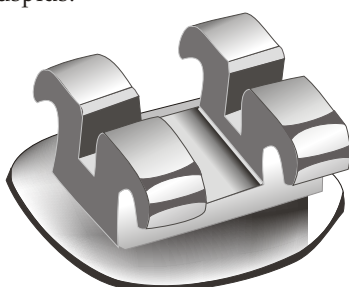
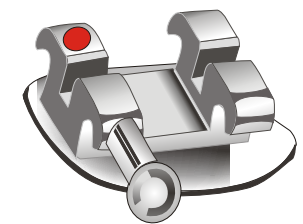

			$\frac{1}{1}$	Upper Centrals
			$\frac{2}{2}$	Upper Laterals
			$\frac{21}{21}$	Lower Centrals & Laterals
			$\frac{3}{3}$	Cuspids with hook
			$\frac{3}{3}$	Cuspids with hook
			$\frac{54}{54} \frac{45}{45}$	Bicuspids

Lingual Brackets

Features

- Mini design with hooks.
- High precision cast design.
- 80 mesh pad on base for perfect bonding.
- Available as 7+7 kits with 6th & 7th molar buccal tubes.

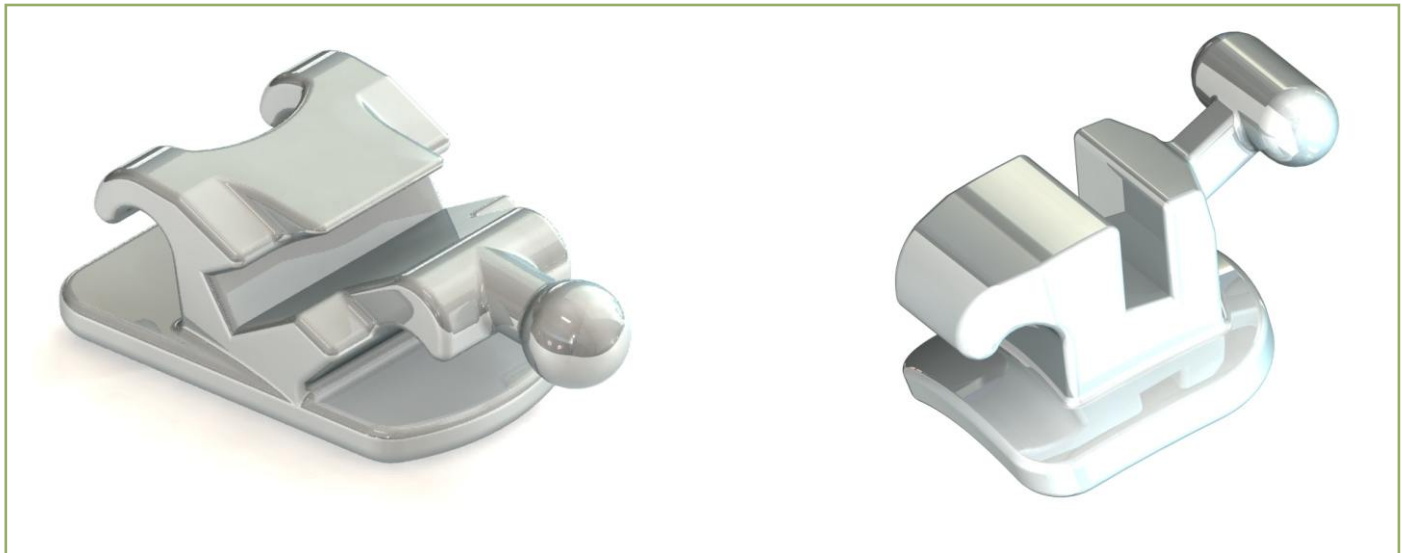
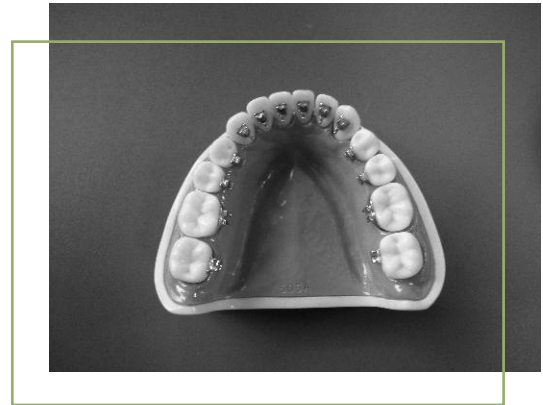

Torque	11	11	55°	55°	55°	55°	55°	55°	11°	11°
Tip	0°	0°	0°	0°	0°	0°	0°	0°	0°	0°
In/out mm	0.5	0.5	0.5	0.5	0.5	0.5	0.5	0.5	0.5	0.5
Width mm	1.9	1.9	2.5	2.5	2.5	2.5	2.5	2.5	1.9	1.9

10°	10°	10°	10°
0°	0°	0°	0°
0.4	0.6	0.6	0.4
3.0	3.8	3.8	3.0

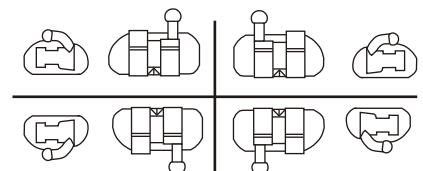
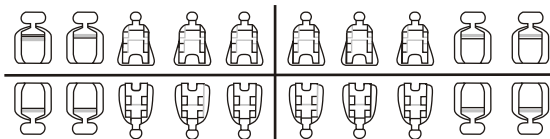

Torque	11	11	40°	40°	40°	40°	40°	40°	11°	11°
Tip	0°	0°	0°	0°	0°	0°	0°	0°	0°	0°
In/out mm	0.5	0.5	0.4	0.4	0.4	0.4	0.4	0.4	0.5	0.5
Width mm	1.9	1.9	2.0	2.0	2.0	2.0	2.0	2.0	1.9	1.9

0°	0°	0°	0°
0°	0°	0°	0°
0.4	0.6	0.6	0.4
3.0	3.8	3.8	3.0

D-Tech Lingual bracket is not claimed to be a analog of any other , nor does D-Tech imply that it is endorsed in any way by others.

Cerabrace™ Polycrystalline brackets

Roth & MBT Prescription

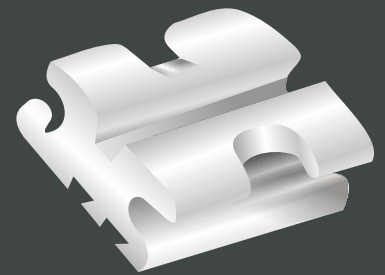
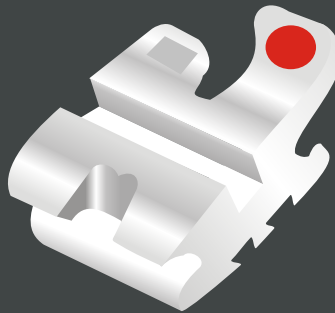

Features

- Integral hooks available on all Cuspids.
- Brackets have very natural look and do not stain or discolor easily.
- Extra smooth for patient comfort.
- Mechanical dove-tail grooves improves adhesion & allows easy debonding. The base is silane treated for better bonding.
- Maximum under tie wing area for the best possible Ligation. Easy to ligate.
- Anatomically contoured base.
- Torque - in - base. Exact tip, torque & in/out movement.
- Patient pleasing aesthetics.

“We are pleased to inform you that , our cerabrace™ customers get a special privilege of ordering any individual bracket. This ensures that you will never be in a tight spot due to accidental breakage ”

Cerabrace is available in both MBT & ROTH prescriptions !!

Our advantage: We can give you custom kits !!

Full kits (20 pcs)	$\frac{515}{515}$
Extraction kits	$\frac{414}{414}$
Upper/Lower (3-3)	$\frac{313}{313}$
Upper only (5-5)	$\frac{515}{515}$
Upper (3-3)	$\frac{313}{313}$

ROTH PRESCRIPTION BRACKETS		DIRECT BOND .018 & .022		
Maxillary	Torque	Angle	Right/Left	Hook
Central	+12	+5	● Right ● Left	
Lateral	+8	+9	● Right ● Left	
Cuspid	-2	+13	● Right ● Left	Hook Hook
Bicuspid	-7	0	● Right ● Left	Hook Hook
1st Molar Single Tube	-14	0	Right Left	Hook Hook

ROTH PRESCRIPTION BRACKETS		DIRECT BOND .018 & .022		
Mandibular	Torque	Angle	Right/Left	Hook
Anteriors	0	0	○ Universal	
Cuspid	-11	+7	● Right ● Left	Hook Hook
Bicuspid	-17	0	● Right ● Left	Hook Hook
Bicuspid	-22	0	● Right ● Left	Hook Hook
1st Molar Single Tube	-25	0	Right Left	Hook Hook

Colour Code/Identification Chart

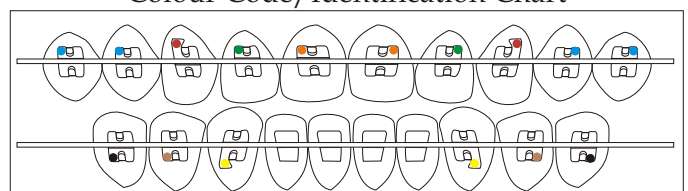

krystal ice™ Monocrystalline bracket

Roth & MBT Prescription

“krystal-Ice is a true monocrystalline bracket that combines aesthetics & strength to give the “perfect natural look”



The Clear Choice for Superior performance in aesthetics

Krystal - Ice Clear Brackets are an invaluable product for orthodontists who want an aesthetic solution for their practices, one that will deliver superb results for patients. **In line with this requirement we have launched the truly transparent monocrystalline bracket called krystal-Ice. “Krystal - Ice™ is unmatched in its aesthetic & cutting edge technology.**

Features

- Excellent sliding mechanics - Ultra smooth heat polished surface dramatically reduces friction.
- Maximum tie wing strength and advanced heat-treatment technology means Krystal -Ice brackets are twice as resistant to breakage as compared to other ceramic appliances.
- Truly transparent - These brackets are virtually invisible and works with any colour of teeth.
- Smooth and comfortable - these brackets are Contoured for patient comfort.
- Easy to debond - The ball base technology reduces required debonding force.

Bond Strength

Magnified photographs show the unique base. The krystal-ice™ bonding base is sintered with zirconia valls creating millions of undercuts that mechanically lock with the bracket adhesive. This process allows for secure retention during the length of treatment and provides for predictable debonding at the end of treatment.

Sintered Zirconia balls at the base improves bonding strength

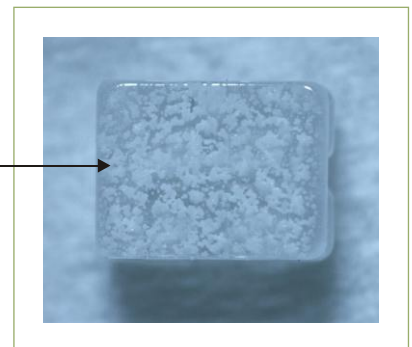

Patient Comfort

Each krystal-ice™ bracket has been diamond and heat polished to produce rounded, smooth corners for uncompromised patient comfort. The small bracket size and low profile design also provide a desirable bracket both clinicians and patients will appreciate. The krystal-ice™ brackets are also functional, the tie wings are easy to ligate, exceptionally strong and highly fracture resistant.

Krystal- ice is available in both MBT & ROTH prescriptions !!

Our advantage: We can give you custom kits !!

Full kits (20 pcs)	$\frac{515}{515}$
Extraction kits	$\frac{414}{414}$
Upper/Lower (3-3)	$\frac{313}{313}$
Upper only (5-5)	$\frac{515}{515}$
Upper (3-3)	$\frac{313}{313}$

Easy Bonding/Debonding



Just squeeze the bracket



SWING™

Self ligating brackets

Special Swing™ tool available for closing & opening cap

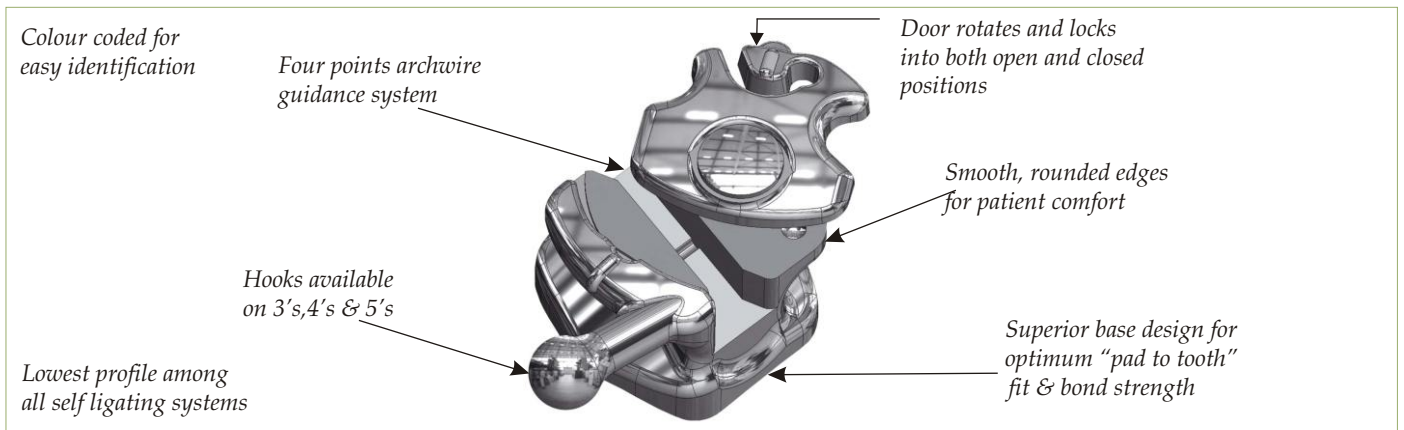

Features

- Hygienic: Radial contours of the bracket follow the natural contours of the teeth creating natural sluice ways for materia alba to wash away from the braces.
- Comfort: Smooth, rounded contours, with no uncomfortable tie wings that stick out, allowing lips and soft tissue to adapt comfortably with the bracket contours.
- Chamfered slot (mesio-distally): Increased inter-bracket distance and chamfered slot dimensions, allow for greater flexibility and ease of arch wire engagement.
- Rotating cap: Unique and easy to use. The Swing™ proprietary rotating cap allows for easier arch wire engagements, by “carrying the wire into the slot” upon archwire engagements.
- Finishing: Unique slot dimensions allow for wires to “couple” more effectively enabling the orthodontist to realize the “true” prescription in the bracket.

Self-ligating system is a low-friction, light force orthodontic solution that delivers healthy tooth movement with optimal control.

The contoured trajectory of the slide and smooth rounded edges along with its low profile Design increase patient comfort while an evolutionary new locking system replaces the need for ligatures. The combination of the Swing™ self ligating bracket and simplified archwire sequences provide remarkable advantages over traditional orthodontic systems ”

ROTH PRESCRIPTION BRACKETS			DIRECT BOND .018 & .022		
Maxillary	Torque	Angle	Offset	M/D In millimeters	In/Out
Central	+12°	+4°	0°	3.30	0.96
Lateral	+10°	+8°	0°	2.92	1.22
Cuspid	-2°	+9°	0°	3.30	0.76
Bicuspid	-7°	0°	0°	3.05	0.76
1st/2nd Molar Single Tube	-14°	0°	+10°		0.42

ROTH PRESCRIPTION BRACKETS			DIRECT BOND .018 & .022		
Mandibular	Torque	Angle	Offset	M/D In millimeters	In/Out
Anteriors	0°	0°	0°	2.64	1.22
Cuspid	-11°	+7°	0°	3.30	0.71
1st Bicuspid	-17°	0°	0°	3.05	0.76
2nd Bicuspid	-20°	0°	0°	3.05	0.76
1st/2nd Molar Single Tube	-25°	0°	+5°		0.42

